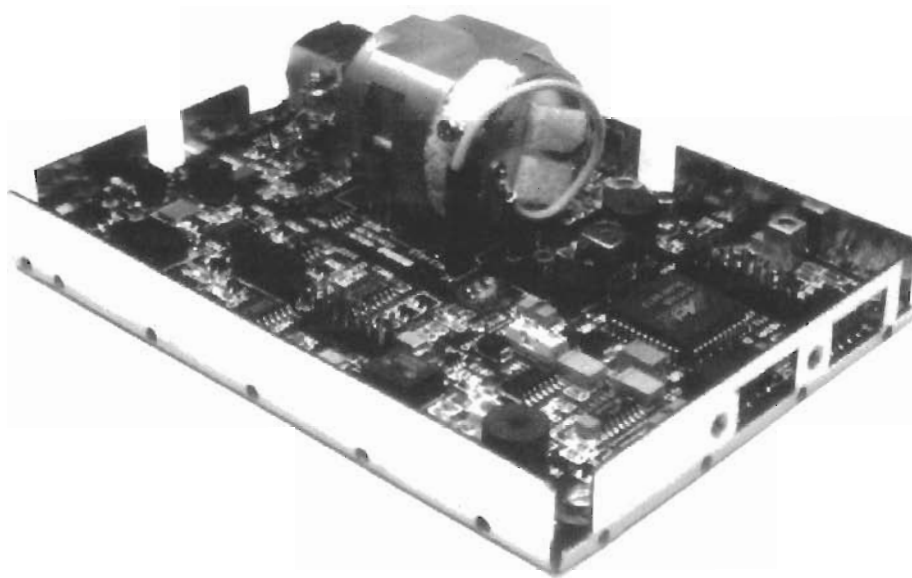


# LPRO

**Rubidium Oscillator  
for Time & Frequency Reference**

---

## **USER'S GUIDE and INTEGRATION GUIDELINES**



# Table of Contents

## REFERENCES

Additional Documentation .....	iv
--------------------------------	----

## SECTION ONE - Introduction and Specifications

1.0 Description .....	1
1.1 Typical Applications .....	1
1.2 LPRO Specifications .....	3

## SECTION TWO - Installation and Operation

2.1 Theory of Operation .....	6
2.2 Installation .....	7
2.2.1 Site Selection .....	7
2.2.2 Cabling .....	7
2.3 Turn-on Procedure .....	7
2.4 Frequency Adjustment Procedure .....	8
2.5 Maintenance .....	10

## SECTION THREE - Design Integration Considerations

3.1 Mechanical Issues .....	11
3.1.1 Recommended Mating Connectors .....	11
3.1.2 Circuit Card Mating Recommendations .....	11
3.1.3 Mounting Guidelines .....	11
3.2 Thermal Considerations .....	11
3.2.1 Use of Thermal Tape .....	11
3.2.2 Test Heat Sink .....	12
3.2.3 Impact of Ext. Ambient Air Temp. on Unit Operation .....	12
3.2.4 Unit Operating Temperature Range .....	13
3.2.5 Frequency Offset from Water Condensation .....	14
3.3 External Interfaces and Grounding .....	15
3.4 Electrical Interface .....	17
3.4.1 LPRO rf Output .....	17
3.4.1.1 Conversion of 10 MHz sine to 10 MHz TTL .....	17
3.4.1.1.1 ac-coupled, CMOS Gate .....	17
3.4.1.1.2 ECL-TTL Level Shifter .....	17
3.4.1.1.3 Use of a LT1016 Comparator .....	19
3.4.1.2 Output Impedance versus Frequency .....	20
3.4.1.3 ac-coupled rf Load .....	20
3.4.2 Transformer-coupled rf Load .....	21

(continued)

## Table of Contents (continued)

### Section Three (continued)

3.4.3 Isolation of Chassis .....	21
3.4.4 Shorted Output, Open Output Cases .....	21
3.5 Built-in Test Equipment (BITE) Signal .....	21
3.5.1 Recommended Customer Interface to BITE .....	21
3.6 C-Field Frequency Control .....	22
3.6.1 $>\pm 1E-9$ Internal or External Control .....	22
3.6.2 Time Response of External C-field Control .....	22
3.6.3 Temperature Compensation of Frequency Using Ext. C-field Control .....	22
3.7 EMI Considerations .....	23
3.7.1 Outer Mu-Metal Cover .....	23
3.8 LPRO Susceptibility to Input Noise .....	23
3.9 LPRO Maintenance .....	24
3.9.1 LPRO Design Goal .....	24

## APPENDIX A

J1 and Board Connector Guidelines and Datasheets .....	25
--	----

## LIST OF ILLUSTRATIONS

Figure 1-1. LPRO Rubidium Oscillator .....	1
Figure 1-2. LPRO Outline Drawing .....	2
Figure 1-3. Total Unit Power Dissipation, Typical (free convection) .....	5
Figure 1-4. Representative LPRO $\Delta f/f$ versus Temperature .....	5
Figure 2-1. LPRO Rb Control Loop Block Diagram .....	6
Figure 2-2. Suggested Connections for LPRO, Initial Turn-on .....	7
Figure 2-3. Top View of LPRO Showing C-Field Adjustment Access Hole .....	9
Figure 3-1. Interface Circuitry of LPRO Connector J1 .....	16
Figure 3-2. Sine-to-TTL Conversion Using C-MOS Logic, Recommended Approach .....	18
Figure 3-3. Sine-to-TTL Conversion, Using C-MOS Logic, Self-Bias Approach .....	23
Figure 3-4. Sine-to-TTL Conversion Circuit, Using Positive ECL Converter .....	23
Figure 3-5. Sine-to-TTL Conversion Circuit Using a High Speed Comparator .....	23
Figure 3-6. rf Output Impedance Versus Frequency .....	24
Figure 3-7. rf Output Impedance Versus Frequency .....	24
Figure A-1. Suggested Mating to Circuit Card Assembly .....	33

## LIST OF TABLES

Table 1a. J1 Connector Interface .....	2
Table 1b. Mating Connector Options .....	2
Table 3-1. Phase Noise, Sine-to-TTL Circuits .....	18

# References

1. **NIST Technical Note 1337, “Characterization of Clocks and Oscillators,”** Sullivan, Allan, Howe, Walls, Editors, March 1990.
3. **“Frequency Stability: Fundamentals and Measurement,”** V. Droupa, Editor, IEEE Press, 1983
4. **“General Considerations in the Metrology of the Environmental Sensitivities of Standard Frequency Generators,”** IEEE Frequency Control Symposium, 1992, pp 816-830.
5. NIST Technical Note 1297, **“Guidelines for Evaluating and Expressing the Uncertainty of NIST Measurement Results,”** 1994 Edition, B. Taylor and C. Kuyalt.
6. **“The Use of Statistics for Specifying Commercial Atomic Frequency Standards,”** DeWatts et al, 1996, Frequency Control Symposium.

# Section 1 - Introduction

## 1.0 Description

The Model LPRO is part of DATUM's family of precision frequency generator components.

The LPRO is designed for low cost mass production. It is easy to integrate into a system, requiring only one input supply voltage and allowing direct plug in connection into another circuit board. It offers the high reliability of a design that has been refined over many years from the experience gained in fielding tens of thousands of DATUM oscillators. It is a one-board package incorporating surface mount technology.

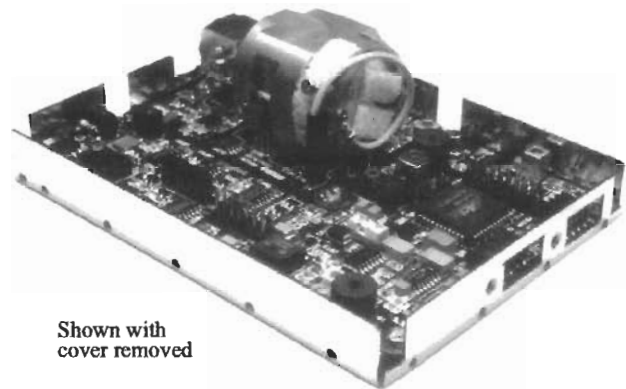
## 1.1 Typical Applications

The Model LPRO is a product DATUM offers for those requiring the high accuracy of a rubidium atomic frequency standard in their system design, but at a price that is competitive with high performance crystal oscillators. The LPRO is designed for ease of integration into time and frequency systems because of its low profile and single circuit board design. The height and footprint are designed to accommodate a 1U VME application, or a 3U VME application. Great care has been taken in the design to minimize EMI emissions and susceptibility, including the use of both a filter plate connector for I/O signals and an outer mu metal cover. The LPRO complies with FCC Article 47, Code of Federal Rules, Part 15, Class A. Operation is subject to the following two conditions: (1) This device may not cause harmful interference, and (2) this device must accept any interference received, including interference that may cause undesired operation. The LPRO also complies with EN55022B and EN50082-1 (see specifications).

The LPRO has been successfully applied to telecom networks such as digital cellular/PCS basestations, SONET/SDH digital network timing, etc. Linked with a GPS receiver, the LPRO provides the necessary timing requirements for CDMA cellular and PCS systems. The low temperature coefficient and excellent frequency stability extend holdover performance when the GPS signal is not available.

The LPRO is designed for long operating periods without maintenance (long life Rb lamp, extended crystal control range) with a goal to exceed 10 years. The design provides a stable frequency with good short and long term stability, and excellent spur performance.

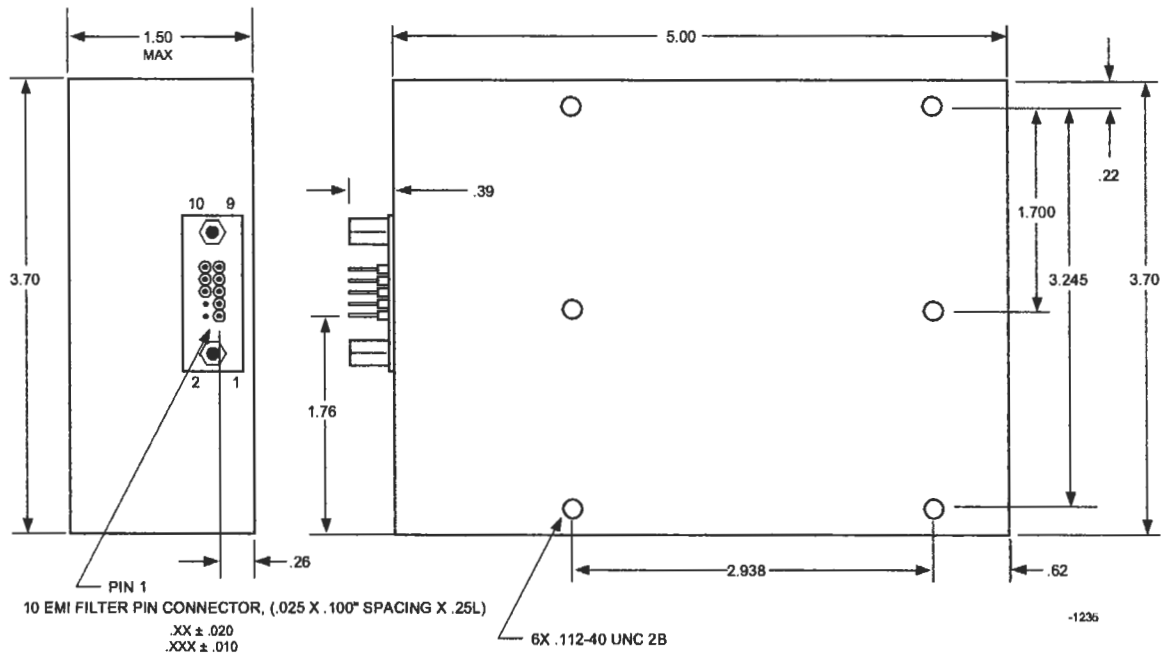
The LPRO provides a 5V CMOS-compatible alarm signal derived from the basic physics operation which indicates when the output frequency is outside roughly  $\pm 5E - 8$  of absolute frequency offset.



Shown with  
cover removed

**Figure 1-1. LPRO Rubidium Oscillator**

# LPRO Rubidium Oscillator



**Figure 1-2. Outline Drawing, LPRO**

**TABLE 1a. J1 Connector Interface**

PIN#	SIGNAL NAME	
1	RF OUT	470 pF PI - FILTER
2	CHASSIS GND	SHORTING PIN
3	RF RTN (CHASSIS GND)	470 pF PI - FILTER
4	CHASSIS GND	SHORTING PIN
5	LAMP VOLTS	1000 pF PI - FILTER
6	BITE* OUTPUT	1000 pF PI - FILTER
7	EXT. C-FIELD VOLTAGE ADJ.	1000 pF PI - FILTER
8	+24V RTN	1000 pF PI - FILTER
9	CRYSTAL VOLTS MONITOR	1000 pF PI - FILTER
10	POWER +24V	1000 pF PI - FILTER

\* Built-In Test Equipment (unlock indicator)

**TABLE 1b. Mating Connector Options**

Mfg. Part No.	No. Positions	Mfg.
87133-2 (shell only)	10	AMP (requires 10 piece 87165-2 connector insert)
CA-10-IDS-T	10	Circuit Assy Corp.
CA-10-IDS2-T	10	Circuit Assy Corp.
622-1000	10	Thomas & Betts
BCS-15-L-D-HE	10	SAMTEC (right angle entry)
BCS-15-L-D-DE	10	SAMTEC (straight in entry)

(This information subject to change without notice)

**NOTE:** Refer to Appendix A for the listed connector manufacturer's specification sheets.

# 1.2 LPRO Specifications

## Electrical Specifications

Unless otherwise indicated, 24V input @ 25°C

**Output/Frequency/Waveform** 10 MHz sine-wave

**Output Level** .55 Vrms  $\pm$ .05 Vrms into  
50  $\Omega$  [+7.8  $\pm$  0.8 dBm]

**NOTE:** refer to LPRO datasheet for additional details on electrical specifications

## Environmental Specifications

**Operating Temperature** -30°C baseplate to +70°C BP

**Temperature Coefficient** (refer to LPRO data sheet)

**Storage Temperature** -55°C to +85°C

**Altitude** Operating: -200 ft. to 40,000 ft. <1E - 13/mbar  
Non-operating: -200 ft. to 70,000 ft.

**Magnetic Field Sensitivity, dc ( $\pm$ 2 GAUSS)**  
Worst Vector: (refer to LPRO data sheet P/N 102502)

**Relative Humidity:**  $\leq$ 85% non-condensing; meet or exceed Telcordia GR-63-CORE Issue 1, October 1995, section 4.1.2.

**Vibration:** Meets or exceeds Telcordia GR-63-CORE, Issue 1, October 1995, section 4.4.3 and section 5.4.2 (no unlock. 1.0 g peak sine @ 5-100Hz).

Non-operating (transportation) Telcordia GR-63-CORE, Issue 1, October 1995, section 4.4.4 and section 5.4.3, curve 1 o

# LPRO Rubidium Oscillator

## Environmental Specifications (continued)

**EMI:** Complies with FCC 47CFR part 15, subpart B, emission requirements for a class B device when connected with shielded cable and connectors in accordance with Section 2.2.2. Cabling, and Section 4.0, Mechanical, Thermal and Power Considerations for the LPRO.

Additionally, the LPRO complies with FCC Article 47, Code of Federal Rules, Part 15, Class A. Operation is subject to the following two conditions: (1) This device may not cause harmful interference, and (2) this device must accept any interference received, including interference that may cause undesired operation.

The LPRO also complies with EN55022B emissions (radiated and conducted) and EN50082-1 immunity.

**MTBF:** Per Telcordia GR-63-CORE Issue 1, (Ground Fixed, Controlled)

Amb. Temp:	20°C	25°C	30°C	40°C	50°C	60°C
MTBF (hrs)	381,000	351,000	320,000	253,000	189,000	134,000

(RELEX software V5.1, part stress, MET 1 case 3)

## Physical Specifications

<b>Weight</b>	1.05 lbs. max.
<b>Size</b>	3.7" X 5.0" X 1.5" H
<b>Warranty</b>	2 years
<b>Extended Warranty</b>	Consult factory

**NOTE:** Contact DATUM Irvine for application support.



# LPRO Rubidium Oscillator

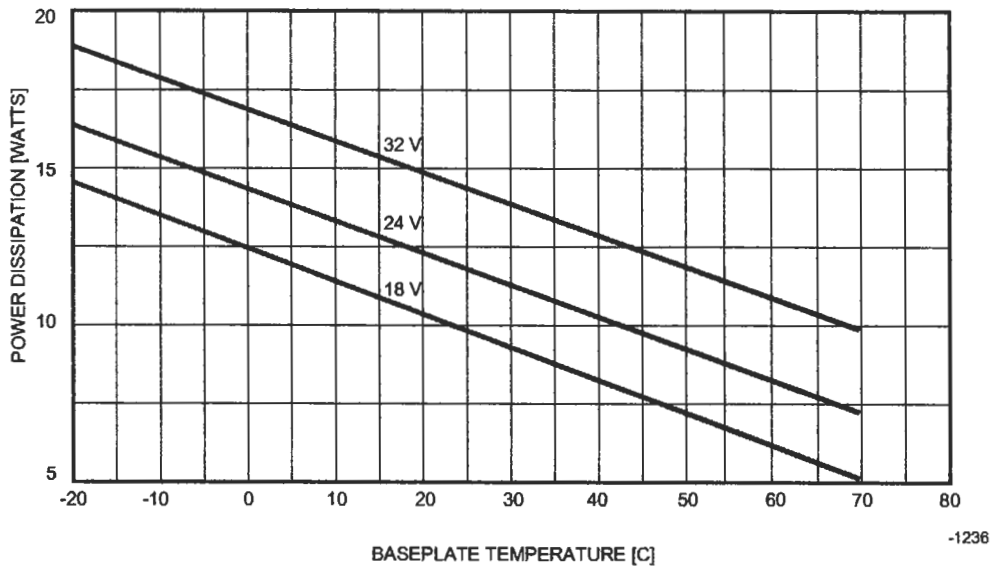


Figure 1-3. Total Unit Power Dissipation, Typical (free convection)

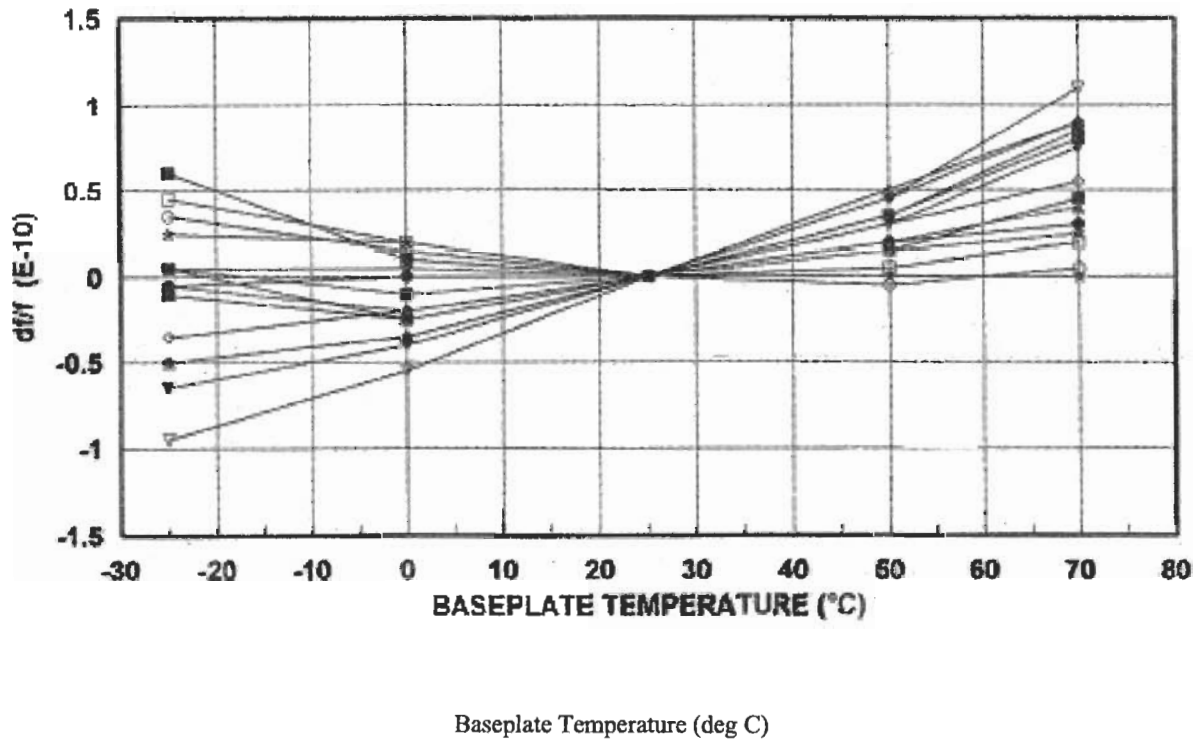


Figure 1-4. Representative LPRO  $\Delta f/f$  versus Temperature

Figure 1-4 illustrates the Tempco performance of nineteen LPRO units as measured across the given temperature range.

# Section 2 - Installation & Operation

## 2.1 Theory of Operation

The Model LPRO makes use of the atomic resonance property of rubidium ( $^{87}\text{Rb}$ ) to control the frequency of an unheated quartz crystal oscillator via a frequency-locked loop (FLL).

The FLL function block is shown in Figure 2-1. A microwave signal is derived from a 20 MHz voltage-controlled crystal oscillator (VCXO) and applied to the  $^{87}\text{Rb}$  vapor within a glass container or cell. The light of a rubidium spectral lamp also passes through this cell and illuminates a photo detector. When the frequency of the applied rf signal corresponds to the frequency of the ground-state hyperfine transition of the  $^{87}\text{Rb}$  atom (an ultra-stable high-Q rubidium atomic resonance), light is absorbed, causing a change (decrease) in photo detector current ( $I_{\text{PH}}$ ).

As the change in current is small, modulation techniques are required to be able to extract the desired signal out of the noise background.

The dip in photo detector current is used to generate a control signal with phase and amplitude information, which permits continuous atomic regulation of the VCXO frequency. The servo section converts the photo detector current into a voltage, then amplifies, demodulates, and integrates it for high dc servo loop gain.

The VCXO output signal is divided by 2 and fed through a buffer amplifier to provide the standard frequency output of 10 MHz. This signal is also frequency multiplied (x3) and fed to a step recovery diode multiplier / mixer circuit along with the modulated synthesizer frequency of 5.3125 MHz ( $17/64 \times 20$  MHz) to generate the microwave frequency. Ignoring modulation components, the microwave frequency component [ $f_{\mu\text{wave}}$ ] selected by the high Q resonator is  $[114 \times 3 \times f_{\text{VCXO}} - (17/64) \times f_{\text{VCXO}}]$ , which is nominally the 6.8346875 GHz rubidium frequency at  $f_{\text{VCXO}} = 20$  MHz.

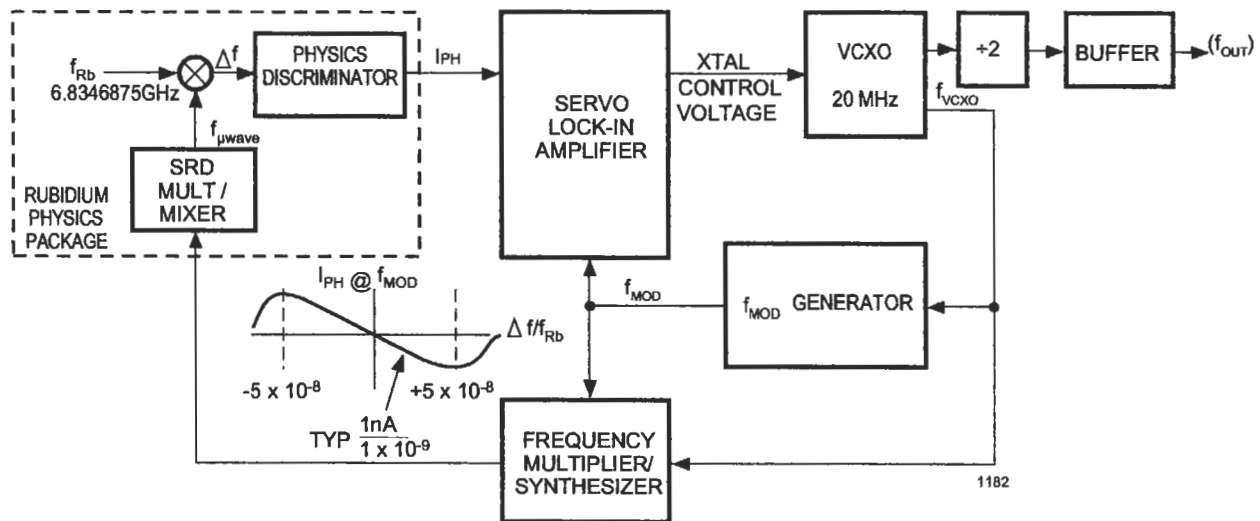


Figure 2-1. LPRO Rb Control Loop Block Diagram

## 2.2 Installation

### 2.2.1 Site Selection

The LPRO installation site should be selected to maintain supply voltage and baseplate temperatures in the range of the specification of Section 1.

The user should ensure that there are no strong magnetic fields at the site since LPRO is sensitive to external dc and ac magnetic fields (refer to specification). An external magnetic field under 2 gauss should not result in measureable permanent frequency offsets for LPRO.

### 2.2.2 Cabling

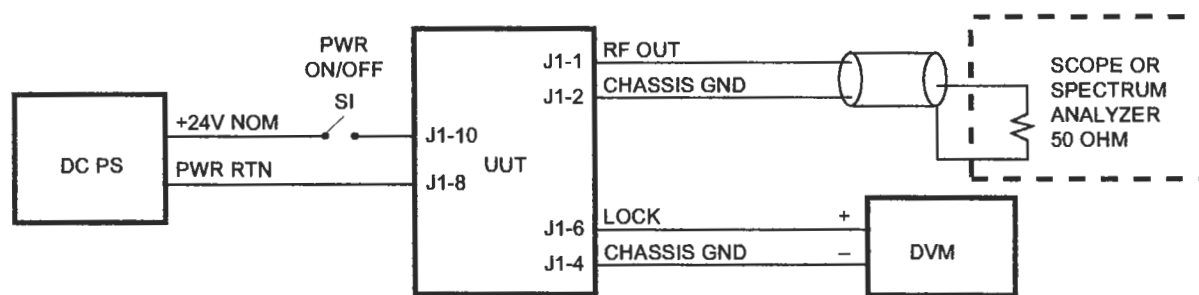
Suggested cabling is found in Section 4.0; Mechanical, Thermal, and Power Considerations for the LPRO.

**NOTE:** *always use shielded cable and connectors to minimize EMI emissions.*

If desired, the LPRO is designed to directly mate to a user's interface board, saving the cost and associated issues of interconnect cabling; a drawing with suggested dimensions is also shown in Figure A-1.

## 2.3 Turn-on Procedure

The LPRO does not have an ON-OFF switch. The unit is powered up by plugging in the unit's J1 connector to a properly terminated cable or the user's interface board. Refer to Figure 2-2 for a block diagram of a suggested hook-up.



1811

**Figure 2-2.** Suggested Connections for LPRO, Initial Turn-on.

The mating connector must provide power (+19V to +32V, +24Vdc nominal) to J1-10 and power return to J1-8. The user's system power supply must be capable of providing a peak source of 1.7 amperes during the warm-up period. After warm-up, this power requirement drops to ~0.5 amperes (@ room temperature).

## LPRO Installation & Operation

If the user's power supply is unable to provide the required peak amperage (1.7 amps), the LPRO warm-up times will be degraded. If insufficient power is provided, the unit may be unable to complete warm-up and a latch-up condition will result. This does not overstress the electronics of the unit. However, it prevents the unit from achieving lock. It can also cause rubidium migration in the lamp, which could prevent the unit from operating properly (it would require servicing).

Connect the rf load to J1-1 (sine 10 Mhz rf out) and J1-2 (rf out return). Note that J1-2 is actually connected to the LPRO's chassis (cover) and internal signal grounds.

Monitor the BITE signal at J1-6 with respect to chassis ground at J1-2 or J1-4, using a high impedance meter (recommended >1 megohm input resistance).

Once the LPRO is plugged in and is receiving power, wait 3 to 4 minutes while the unit achieves atomic lock. During this period, the monitored BITE signal should be HIGH (4.2 Vdc to 4.8 Vdc). Once the unit achieves atomic lock, the BITE signal goes LOW (<50mV with respect to GND). At this point, the output frequency should be approximately  $\pm 5E-8$  of absolute frequency.

Thirty minutes after applying power to the LPRO the rf output frequency will be very close to full accuracy (refer to LPRO specifications, or Reference 1 for information about accuracy versus time from turn-on).

**NOTE:** the output frequency of the LPRO is more accurate than most counters. See Reference 2 for a discussion of methods that allow the verification of atomic frequency standards similar to the LPRO. Appropriate measurement equipment can be obtained from EFRATOM. Ask EFRATOM Marketing, or your local sales representative, about the FMS-200 and FMS-201 product line.

## 2.4 Frequency Adjustment Procedure

There are two primary reasons to adjust the external frequency output of the LPRO. The first is to compensate for aging over time, and the second is to syntonize the rubidium oscillator to a more accurate primary frequency source. The LPRO is considered to be a secondary frequency standard (i.e., much more accurate than a quartz frequency standard, but not as accurate as a cesium standard, which is considered to be a primary standard). By syntonizing the LPRO's rubidium oscillator to an external cesium clock, or GPS satellite, it can be readjusted periodically to match the primary standard's slower aging rate and greater accuracy.

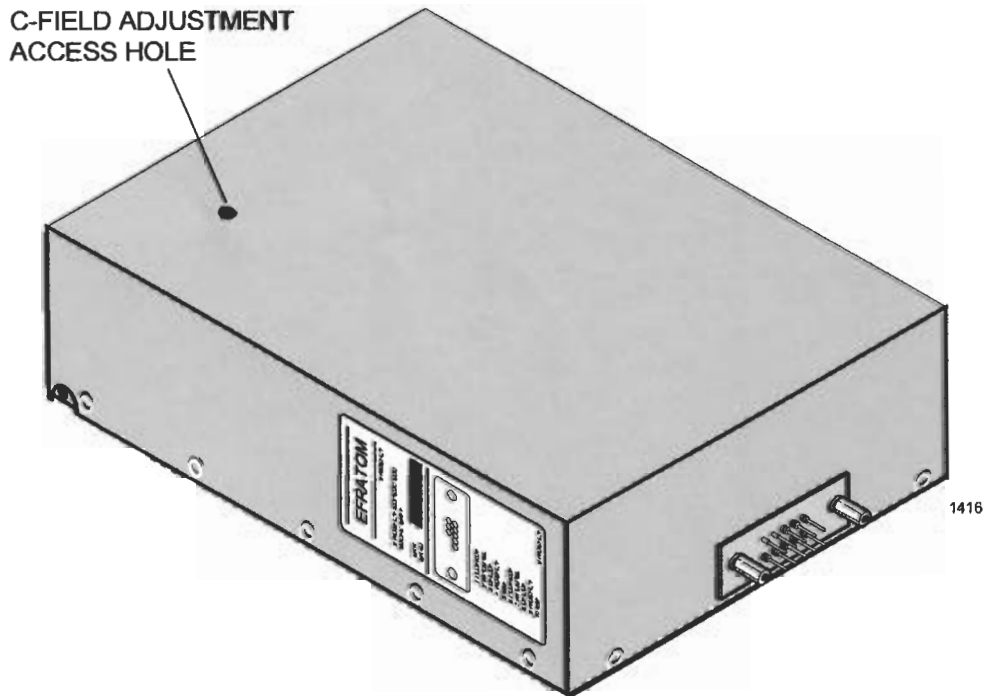
There are two mechanisms to adjust the output frequency by the user. Both methods result in a change in the current through a coil (the unit's "C-field" coil, which is wrapped around the resonance cell of the frequency standard, in turn adjusting the internal magnetic field of the resonator). There are two ways to manipulate the strength of the C-field coil effect. The first is electromechanical, by adjusting the external C-field potentiometer accessible through a small hole in the top cover of the unit (refer to Figure 2-2). Rotation of the slotted adjustment screw of the potentiometer produces frequency change. (Use of a small straight edge can accomplish this task.) A screwdriver is adequate. **Do not force rotation, damage to the potentiometer can result.**

## LPRO Installation & Operation

The second method of adjustment is electronic, using the External C-field control signal at pin J1-7. The unit is set to a nominal 2.5Vdc signal at the factory through this pin. Increasing the voltage will increase the output frequency. The allowable correction range is 0Vdc to +5Vdc, although positive voltages up to 36Vdc can be applied without causing damage or latch-up. Operating with negative voltages at J1-7 is not recommended, as latchup of the internal op amp can result when a voltage more negative than -8 Vdc is applied.

Using an external counter suitable for the task (this operation requires a measurement accuracy that exceeds most counters), adjust the unit so that the output rf frequency is 10,000,000.000 Hz.

**NOTE:** if the LPRO's output signal frequency must be changed, this can be done electronically by connecting the positive voltage of a low output impedance voltage reference to J1-7 and its return to J1-2 (or J1-4, chassis ground). The recommended output impedance is <1 k ohms for the reference voltage, although a higher output impedance can be tolerated (the input impedance for this signal is approximately 151 k ohms). Increasing the positive voltage provides an increasingly positive frequency offset. The correction voltage range is 0 to +5Vdc, where no external frequency offset correction is nominally at 2.5 Vdc.



**Figure 2-3.** Top View of LPRO Showing C-Field Adjustment Access Hole

## **2.5 Maintenance**

### **2.5.1 Repairs**

The LPRO is not field repairable. If the unit should fail, **DO NOT REMOVE THE COVER OF THE UNIT** and attempt to make repairs. Instead, call the DATUM Customer Support Group for the best way of returning the unit to DATUM.

Send to:

**Customer Support  
DATUM Irvine  
9975 Toledo Way,  
Irvine, CA 92718-1819**

Telephone (949) 598-7600

Fax: (949) 598-7876 (to obtain return procedures from Customer Support)

Fax: (949) 598-7650 (Marketing)

Fax: (949) 598-7651 (Marketing)

# Section 3 - Design Integration Considerations

## 3.1 Mechanical Issues

### 3.1.1 Recommended Mating Connectors

Refer to Section 1 and Appendix A for information on appropriate mating connectors and manufacturer's data sheets.

### 3.1.2 Circuit Card Mating Recommendations

Refer to Appendix A for connector recommendations.

### 3.1.3 Mounting Guidelines

#### 3.1.3.1 LPRO Attachment to an external Chassis or Circuit Card

Always use shielded cables and connectors (refer to Tables 1a and 1b for the signal/pin assignments, and Appendix A for connector information). The LPRO can also plug directly into a customer's circuit card assembly, saving the cost of cabling. Refer to Figure A-1 in Appendix A for details.

#### 3.1.3.2 Baseplate Mounting

The LPRO has six mounting hole locations on its bottom cover that require a #4-40 screw with a minimum penetration depth of 1/8". The bottom cover can accept a maximum screw penetration depth of 1.25" without damage (a longer screw will hit the top cover). Torque each screw to 4.5 inch pounds minimum, 5 inch pounds nominal when using the recommended stainless steel screw.

## 3.2 Thermal Considerations

### 3.2.1 Use of Thermal Tape

It is critical to obtain a good thermal contact from the bottom ("baseplate") of the LPRO to the mounting surface in order to achieve the highest ambient operating temperature for the specified LPRO operating baseplate temperature. It is also very important to maintain a uniform heat sink temperature because of uneven heat flow into the baseplate of the LPRO through its various mounting points. For this reason, the LPRO Accessory Kit (DATUM P/N 102509-001) includes thermal tape (DATUM P/N 102515-001) precut for the LPRO outline and mounting hole pattern.

## LPRO Design Integration Considerations

### 3.2.2 Test Heat Sink

A heat sink or mounting base plate is required to keep the baseplate temperature under 70°C. Internal self heating of the LPRO will cause local internal temperatures to exceed DATUM's part derating guidelines when used without a heatsink or forced air. (although the maximum manufacturer's operating temperature ratings will not be exceeded). A heat sink with thermal resistance to ambient of less than 2°C/W is required for ambient of 50°C maximum. For test purposes, an optional heat sink is available. Order P/N 102518-001 from DATUM.

### 3.2.3 Impact of External Ambient Air Temperature on Unit Operation

The power consumption for LPRO versus baseplate temperature is shown in Figure 1-3. The behavior is dominated by three mechanisms; the resonator heater power, the lamp heater power, and the electronics power. The resonator heater power is determined primarily by the resonator control temperature of +78°C, the baseplate temperature, and the 15.3 C/W thermal resistance from the resonator to baseplate. The lamp heater power is determined primarily by the lamp control temperature of +110°C, the baseplate temperature, and the 53 C/W thermal resistance from the lamp to baseplate. The electronics power reflects nearly a fixed electronic current that is independent of input voltage due to the unit's internal 17 V regulator and is roughly independent of baseplate temperature. The heater powers are roughly independent of input voltage.

An equation to approximate quiescent input power consumption for the unit is:

$$P_Q \approx \underbrace{\{V_{PS} * (280 \text{ mA})\}}_{\text{electronics pwr}} + \underbrace{\{[(78^\circ\text{C} - T_{BP}) / (15.3^\circ\text{C/W})]\}}_{\text{resn htr pwr}} + \underbrace{\{[(110^\circ\text{C} - T_{BP}) / (53^\circ\text{C/W})]\}}_{\text{lamp htr pwr}}$$

This equation is only an approximation, since it ignores effects like internal self-heating, power losses from the heater reverse protection diode, and power losses from the heater current sense resistors.

The LPRO maximum baseplate temperature described in the specifications was based on a model where the unit was covered on five sides with one inch foam to simulate free convection in air as the heat sink/baseplate was exposed to forced air.

The maximum operating baseplate temperature will be lower by several degrees C if the external air is hotter than the baseplate mounting. An example is a situation where the baseplate is being cooled by a thermoelectric cooler, but is exposed to nearby heat-producing equipment.

If there is air flow over the unit's top cover, the LPRO's maximum operating baseplate temperature will increase by 1 or 2 degrees C and its power consumption at a given baseplate temperature will also increase by a few tens of milliwatts.



## LPRO Design Integration Considerations

### 3.2.4 Unit Operating Temperature Range

There are three scenarios of interest concerning the operating temperature range for LPRO. The three scenarios are differentiated by performance for conditions including the turn-on / warm-up period, standard operation after warm-up is completed, and emergency operation after warm-up is completed.

The turn-on / warm-up period includes the time for the internal heater circuits to obtain thermal equilibrium, for the lamp to ignite into a plasma discharge, for the standard to achieve atomic lock, and for the crystal operating temperatures to reach its normal operating temperature range.

The three scenarios are:

- Scenario 1. The operating temperature range below the normal temperature range without guaranteed warm-up, but with full frequency control
- Scenario 2. The normal temperature range with full performance, including warm-up
- Scenario 3. The operating temperature range above the normal temperature range, excluding guaranteed warm-up, but without loss of lock.

All scenarios are defined in terms of the unit's baseplate temperature (the bottom surface of the bottom cover) and are described below.

1. *Temperature range -35°C baseplate to -20°C baseplate.* This operating temperature range allows full frequency control, but excludes normal warm-up. The cold temperature limit is based on the use of a -30°C/+85°C unheated crystal, and an internal temperature rise at the crystal of ~6°C. The hot temperature limit is based on staying under the maximum operating temperature of the crystal, avoiding loss of thermal control of the resonator heater, and not exceeding the operating derating guidelines of selected LPRO components.

2. *Temperature range -30°C to +70°C.* The normal operating temperature range with specified warm-up capability included. This temperature range excludes that of scenario 1, because of the unheated crystal used in the LPRO. The unit will not be damaged when operated between -35°C and -30°C, but a guaranteed performance cannot be ensured until the circuit board near the crystal begins to warm; a 6°C rise occurs thirty minutes to one hours after turn-on.

3. *Temperature range from 70°C to 75°C baseplate.* This is the emergency operating temperature range that maintains lock (but has no guaranteed warm-up period). The upper limitation is derived by staying under the upper operating temperature of the crystal as well as avoiding the loss of thermal control of the resonator. This condition is not recommended for long operating period because once heater control is lost, the unit may take on a frequency offset (typically parts in  $10^{-11}$ ) that will be present for many days of operation while the unit returns to equilibrium. Also, DATUM part derating guidelines are exceeded under this condition, although the component manufacturer's maximum part rating guidelines are not, provided the baseplate temperature is kept below 75°C.

## LPRO Design Integration Considerations

When thermal control is lost the result is a large rate of change of frequency versus temperature. As the baseplate temperature increases the unit will eventually lose lock. As described in the Theory of Operation section of this manual, the physics package acts as a discriminator that compares the injected microwave frequency to the hyperfine transition frequency of rubidium 87 (6.834687500 GHz). The output signal drops rapidly as the resonator temperature increases above the set point. When the output signal drops low enough, the unit can no longer maintain internal lock. When the resonator or lamp heaters shut down because no power is required to sustain control point temperatures, the unit temperature coefficients are about  $5E-10/^{\circ}C$  temperature change.

### 3.2.5 Frequency Offset from Water Condensation

Condensation of moisture from the air onto electrical components will produce frequency spikes or instability until the heat of the operating unit drives out the water vapor. Condensation is more of a problem when a cold unit is warming up rapidly, because the temperature of the internal surfaces of the LPRO will lag the temperature changes of the outside ambient air, and an influx of hot, humid air will hold enough moisture to condense out on the colder surfaces.

Condensation will not cause a problem for environments meeting the LPRO specification if the LPRO baseplate thermal ramp rates are controlled so that they rise at less than  $2^{\circ}C/minute$ .

### 3.3 EXTERNAL INTERFACES and GROUNDING

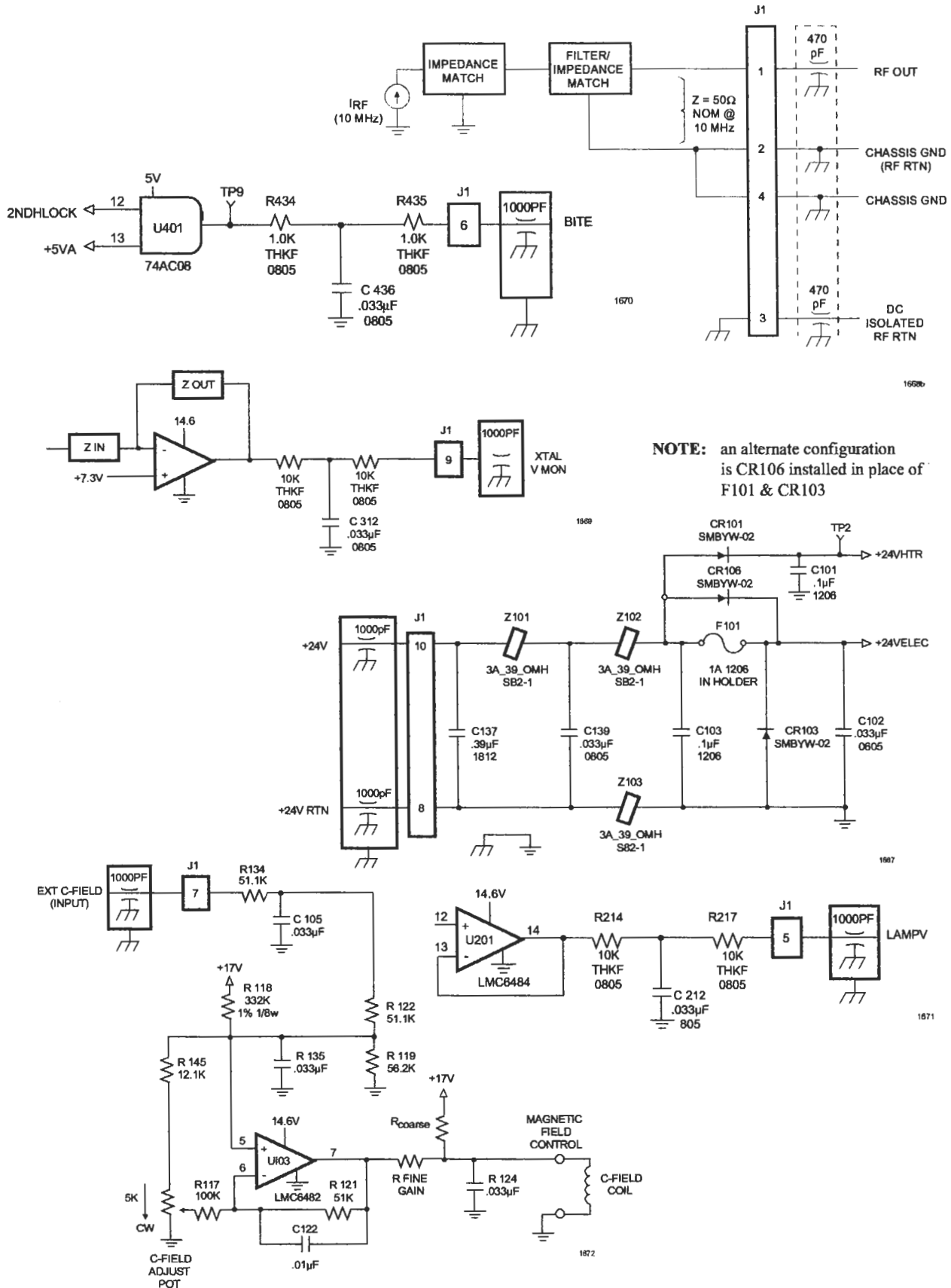
Figure 3-1 shows interface circuitry for J1, the LPRO I/O connector. All signals, including power, power return, rf output, signal/chassis ground, and monitor lines are routed through this connector.

The LPRO is constructed with the chassis (unit cover) and signal grounds tied together at multiple points, and with the power supply return isolated from both chassis and signal grounds only by a ferrite bead. This robust grounding approach allows for ESD protection and low spurious emissions. But it can also lead to ground loop issues for the user. Workarounds commonly used to break dc ground loops at a higher level of integration are to isolate the LPRO cover/chassis from the user's chassis, use a rf isolation transformer for the 10 MHz rf output, and/or float the transformer secondary winding of the user's power supply.

J1 signals are routed through a filter plate selected for EMI and ESD purposes. Three filter pin types are utilized for the filter plate;

1. 1000 pF PI feedthrough capacitor/ferrite for power/power return and monitor signals
2. 470 pF PI feedthrough capacitor/ferrite for the rf and dc isolated rf return signals, and . . .
3. shorting pin for the two chassis ground pins (either one of which is the recommended rf return pin).

# LPRO Design Integration Considerations



**NOTE:** an alternate configuration is CR106 installed in place of F101 & CR103

**Figure 3-1. Interface Circuitry of LPRO Connector J1**

## 3.4 ELECTRICAL INTERFACE

### 3.4.1 LPRO rf Output

#### 3.4.1.1 Conversion of 10 MHz sine to 10 MHz TTL.

The LPRO was designed for a 10 MHz sine output with a 50 ohm source impedance at 10 MHz and for a 50 ohm load. The sine output permits built-in ESD and EMI protection even for the rf output signal, (the filter plate capacitance for the rf output signal is built into the matching circuit). The connector scheme is designed for direct plug-in of the LPRO J1 filter plate connector into the customer's circuit board connector, saving the cost of a cable harness.

Transmitting rf output signals over long distances is less of an EMI issue for the user when the signal is a sine wave instead of a square wave because a sine wave lacks harmonics. In addition, the power consumption of the sine wave driver into 50 ohms is lower than for a square wave driver into 50 ohms, especially when providing short circuit protection.

Because some users require a square wave for their application, this section identifies a number of potential methods for the conversion. Keep in mind that any circuitry shown must be verified by the user in their particular application. And no endorsement of any specific manufacturer's product is intended.

Refer to Table 3-1 for a comparison of the phase noise resulting for each of the circuits based on a test sample of one. Note that with the low noise source used there was no degradation in phase noise performance seen for the circuits illustrated in Figure 3-2 and only mild degradation for the circuit in Figure 3-3.

##### 3.4.1.1.1 ac-coupled, CMOS gate

Two topologies are shown in Figures 3-2 and 3-3. The topology of Figure 3-3 has significantly less supply voltage sensitivity than that of Figure 3-2, but dissipates high power if the rf signal is removed (if implemented, the user should be aware of potential reliability issues for this mode of operation).

The best logic family found for low phase noise is AC or ACT logic. However, the faster logic families such as AC and ACT logic have more EMI issues via the power and ground lines because they charge and discharge internal and external capacitances faster and because of the lower drive impedances (higher emissions from the faster waveform edges). If EMI emissions are an issue, a slower logic family may be in order. The use of a small series resistor from the output of the gate to the load can reduce emission problems. Good local power bypassing is recommended for this application, such as a small series resistor and a low ESR tantalum supply bypass capacitor.

##### 3.4.1.1.2 ECL-TTL Level Shifter

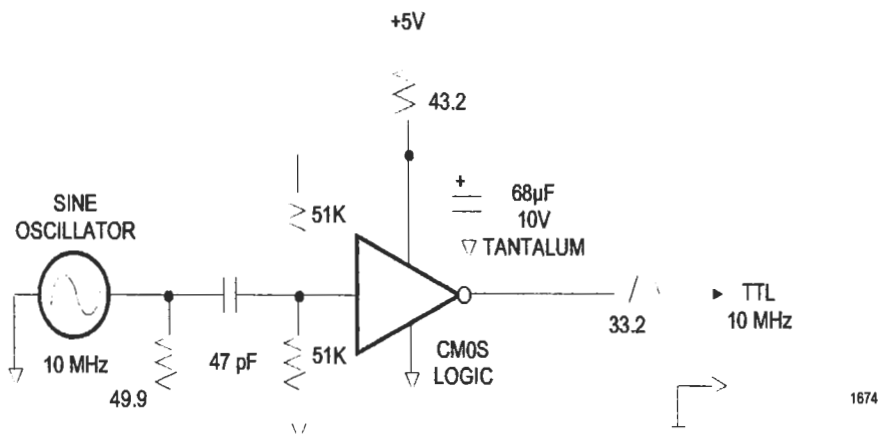
Figure 3-4 shows a sine to TTL converter using a positive ECL to TTL converter microcircuit. The advantage to this approach is the lack of supply and ground noise. Disadvantages are higher phase noise and cost (compared to the ac-couple, CMOS approach), and the extra power dissipation (roughly 18-23 milliamperes more at 5V).

## LPRO Design Integration Considerations

**Table 3-1. Measured Phase Noise, Sine-to TTL Circuits**

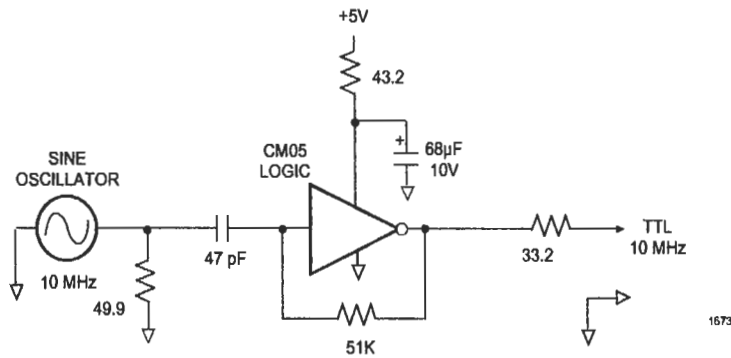
Figure	1 Hz -dBc/Hz	10 Hz -dBc/Hz	100 Hz -dBc/Hz	1 kHz -dBc/Hz	10 kHz -dBc/Hz	100 kHz -dBc/Hz	Test Notes
3-2 (74AC04)	99	130	149	158	159	161	2
3-3 (74AC04)	102	130	149	155	157	159	2
3-4 (MC10ELT21D)	101	129	134	135	135	135	2, 3
3-5 (LT1016)	98	118	118	119	119	120	2, 4
TYP LPRO	86	96	138	152	156	158	1
FRK LN	103	130	149	158	160	161	1

1. The Wenzel oscillator was used as a reference source for the phase noise test set.
2. The FRK-LN oscillator was used as a driving source for the sine-to-TTL circuit. This oscillator was screened for best phase noise.
3. Test Figure 3-4 with Figure 3-3 used as a buffer, since Figure 3-4 cannot drive the low 50 ohms test.
4. Test Figure 3-5 with Figure 3-3 used as a buffer, since Figure 3-5 cannot drive the low 50 ohms test.

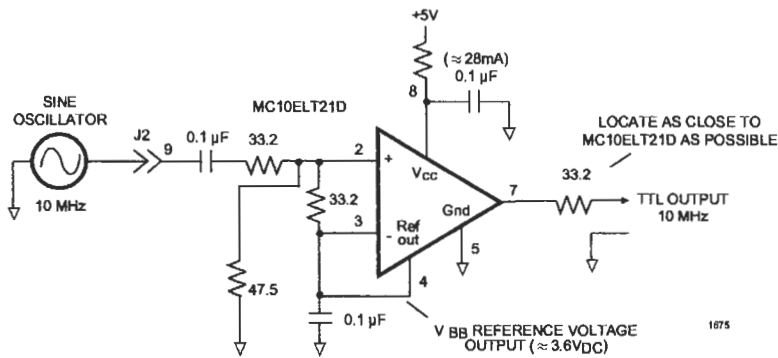


**Figure 3-2. Sine-to-TTL Conversion, Using C-MOS Logic, Recommended Approach**

## LPRO Design Integration Considerations



**Figure 3-3.** Sine-to-TTL Conversion, Using C-MOS Logic, Self-Bias Approach



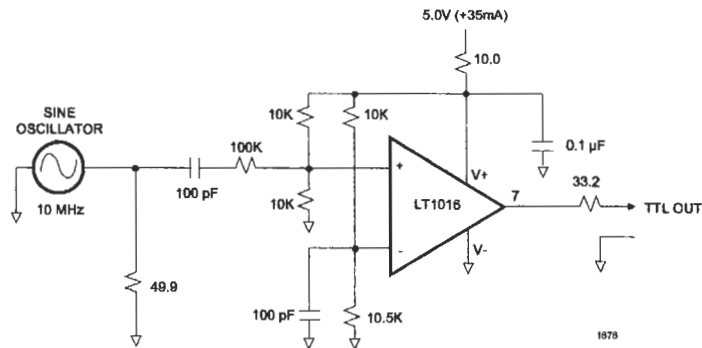
**Figure 3-4.** Sine-to-TTL Conversion Circuit, Using Positive ECL Converter

### 3.4.1.1.3 Use of a LT1016 Comparator

Figure 3-5 shows a sine to TTL converter using a high speed comparator. The advantage of this approach is the lower supply and ground noise compared to the ac-couple, high speed CMOS approach. The disadvantages are the higher phase noise and cost (compared to the ac-couple, CMOS approach), and the extra power dissipation (~24-29 milliamperes more at 5V).

### 3.4.1.2 rf Output Impedance versus Frequency

Figures 3-6 and 3-7 show the active rf output impedance for LPRO. It shows a nominal 50 ohms at 10 MHz, but a widely varying impedance at other frequencies. This would have to be taken into consideration by the user if running the LPRO rf output into a non-buffered filter.



**Figure 3-5.** Sine-to-TTL Conversion Circuit Using a High Speed Comparator

## LPRO Design Integration Considerations

### 3.4.1.2 rf Output Impedance versus Frequency

Figures 3-6 and 3-7 show the active rf output impedance for LPRO. It shows a nominal 50 ohms at 10 MHz, but a widely varying impedance at other frequencies. This would have to be taken into consideration by the user if running the LPRO rf output into a non-buffered filter.

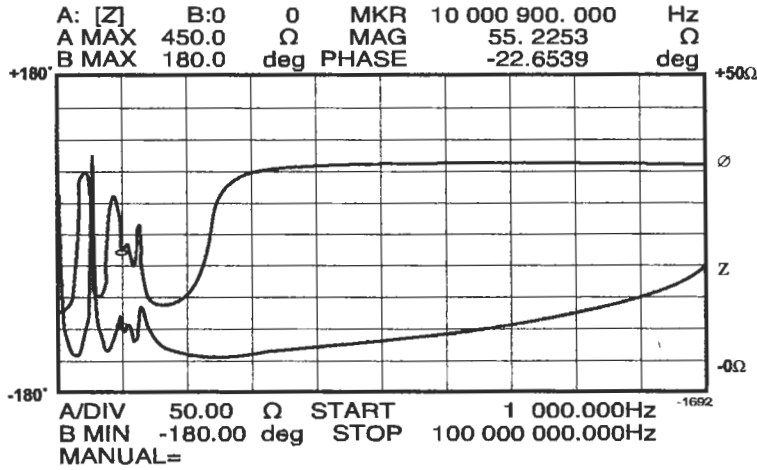


Figure 3-6. rf Output Impedance Versus Frequency

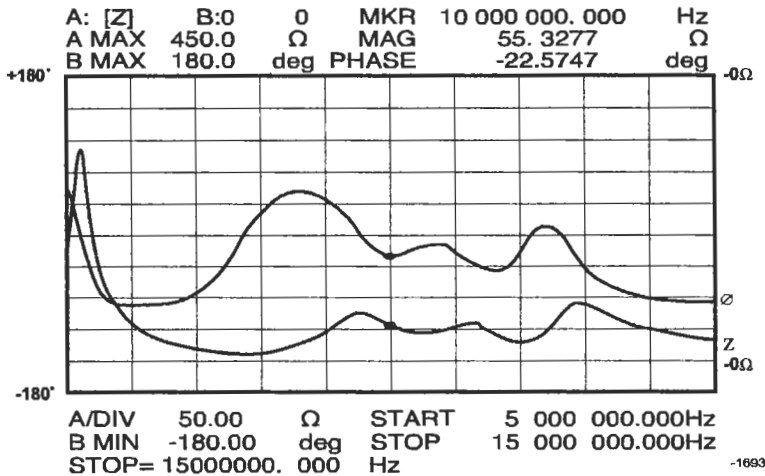


Figure 3-7. rf Output Impedance Versus Frequency

### 3.4.1.3 ac-Coupled rf Load

The LPRO is designed to tolerate an ac-coupled rf load without waveform distortion provided the coupling capacitor is low impedance at 10 MHz (for example, a 0.01 uF capacitor has an  $X_c$  of 1.6 ohms, which is small compared to the fifty ohm nominal output impedance). The rf output stage of the LPRO uses an ac-coupled design.

It is recommended that the coupling capacitor be ceramic, with a X7R or NPO dielectric.



## LPRO Design Integration Considerations

### 3.4.2 Transformer-coupled rf Load

The transformer-coupled rf load is used to break up ground loops. It can also be used to provide some bandpass filtering. However, it also attenuates the rf signal, making it difficult to provide a tight tolerance on the rf output level. It is also difficult to obtain an inexpensive, off-the-shelf wide operating temperature range SMT rf transformer.

### 3.4.3 Isolation of Chassis

The LPRO can be electrically isolated from the user's chassis via a thermally conductive insulator and with the use of insulating shoulder washers for the baseplate insulation.

### 3.4.4 Shorted Output, Open Output Cases

The LPRO is designed to tolerate a short to ground of the rf output without damage, providing a rf output signal amplitude at approximately twice the normal output level of that from a fifty ohm load. This condition actually provides the worst case stress on the rf output driver stage transistor, but the derating guidelines are still followed for this part (less than 125°C junction temperature at the maximum operating baseplate temperature).

## 3.5 Built In Test Equipment (BITE) Signal

The LPRO provides an indication that the internal Voltage Controlled Crystal Oscillator (VCXO) is locked to the atomic transition via the BITE signal. As long as the BITE signal is LOW once warm-up is completed, the user can be assured that the output frequency is within roughly  $\pm 5E-8$  of absolute frequency.

If the BITE signal is high, atomic lock has been lost and the VCXO will go into sweep mode to reacquire lock. The sweep ranges approximately from -17 ppm to +18 ppm in approximately a 20 second period. Note that during this lock acquisition period a cumulative time error can be expected. The resulting overall time error will average out during the sweep period to that obtained from a constant frequency offset at roughly the net difference between the sweep endpoints (although nonlinearity of the sweep will give further errors).

### 3.5.1 Recommended Customer Interface to BITE

The internal LPRO BITE signal interface includes components for EMI filtering and ESD protection (see Figure 3-16). The internal filtering impedance and response times must be taken into account by the user when utilizing the BITE signal. Standard TTL and LS-TTL draws too much current for the interface series output resistance of 2 kohms used by the LPRO, while standard CMOS circuitry may oscillate during the slow transition through the active region during BITE level changes.

It is recommended that either Schmitt trigger CMOS logic (for example, 74HCT14A, MM74HC14, 74ACT14, and CD40106) or a high input impedance (FET input) comparator with hysteresis are used for the interface to the BITE signal.

## 3.6 C-Field Frequency Control

### 3.6.1 Greater Than $\pm 1\text{E-}9$ Internal or External Control

The C-field control circuitry is designed to independently sum the contributions of the C-field control potentiometer and the external C-field control signal. Each control signal gives greater than  $\pm 1.5\text{E-}9$  frequency offset correction capability.

The external C-field control circuitry is designed so that with no voltage applied at J1-7, the voltage will self bias to mid-range, or 2.5V.

### 3.6.2 Time Response of External C-field Control

The external C-field control has a response time that is dominated by the rubidium servo loop bandwidth, which yields a typical time constant of 23 ms. There are several other time constraints present, but they are all more than a factor of 10 faster.

### 3.6.3 Temperature Compensation of Frequency Using External C-field Control

One of the key specifications for an atomic frequency standard is the temperature coefficient. The LPRO is designed for a low temperature coefficient without the need for temperature correction. However, in applications where the user requires a tighter temperature coefficient, a common practice is to monitor the baseplate temperature of the LPRO and apply a correction signal via the External C-field Adjust (pin 7 on connector J1).

This method can be successfully used for moderate correction, for example to bring the maximum frequency change over the full operating temperature range to less than  $1\text{E-}10$ . Applying more correction is possible, but there are limits without issues for both yield loss and the test time required for correction, as one runs into the inherent problems of subtracting two large numbers to accurately and consistently obtain a small difference.

Compensation using this scheme is suitable only for steady state conditions. This is because of inherent mismatches between the thermal time constants of the mechanisms that cause temperature coefficient errors, and because of the thermal time constant of the monitoring circuitry. Transients from time constant mismatches will show up; these transients are minimized if temperature ramp rates are limited. Changing less than  $+2^\circ\text{C/minute}$  baseplate temperature should result in negligible transients from mismatches.

There are issues with changing the C-field current in atomic frequency standards for the impact on aging and other parameters, but this is more of an issue for expensive laboratory frequency standards with significantly tighter aging specifications than a LPRO unit.

## 3.7 EMI CONSIDERATIONS

### 3.7.1 Outer Mu-Metal Cover

The resonator packages of rubidium frequency standards have significant frequency offsets due to external magnetic fields. For this reason, it is customary to use a double mu-metal shield for the resonator housing in order to meet the magnetic susceptibility specification for the unit of parts in  $10^{-11}$ /gauss.

The LPRO was designed so that the unit cover forms the second, outer magnetic shield. The cover is made of mu-metal, with overlapping edges that minimize problems with fringing fields. The advantage of this approach is the resulting magnetic shielding of the electronics outside of the resonator package.

## 3.8 LPRO Susceptibility to Input Noise

When a user has an application where the output spectrum phase noise and spur integrity is crucial, the LPRO must be provided with comparatively clean source of dc power (free of spurious current or voltage noise). Connecting fans and other electromechanical devices to the dc supply powering the LPRO can result in degraded phase noise and spur performance. This is because motors with brushes can create a wide spectrum of noise. The frequency spectrum of the spurs will vary largely with the motor's speed and load conditions.

The Rb atomic frequency source uses a modulation/demodulation lock-in amplifier scheme with a modulation frequency of  $\sim 152$  Hz. Inherent in this approach is sensitivity to noise at multiples of the modulation frequency. This noise is coupled through both the heater and electronic power lines to cause modulation spurs on the output frequency. Care should be taken to avoid the modulation frequency and its lower harmonics (roughly up to the tenth harmonic).

The LPRO has an internal linear regulator supplying power to the critical electronics, including the crystal oscillator, which is the source for the 10 MHz output. This regulator loses its ripple rejection attributes at frequencies greater than 100 kHz. The crystal oscillator in the unit has some filtering to minimize the conductive spurs from affecting the oscillator. It remains critical that a clean input supply is used if spur and phase noise performance is critical for the end user application. This topic is discussed further in the LPRO Data Manual.

### 3.9 LPRO Maintenance

#### 3.9.1 LPRO Design Goal

The LPRO is designed with a goal of ten years of maintenance-free operation. In order to accomplish this, the major mechanisms impacting the need for maintenance were addressed. Thus, each LPRO has been designed to have sufficient rubidium fill in the lamp to last for the required period, sufficient pulling range for the voltage controlled crystal oscillator, and sufficient dynamic range of the rubidium control loop.

As stated in Section 2, with the exception of frequency adjustment via the fine frequency control potentiometer, or the external C-field adjusting signal, there is no tuning that need be performed by the user. If problems arise in LPRO operation, contact DATUM Customer Support for guidance. The LPRO is considered to be factory serviceable only.

Monitor signals are provided to allow the user to track indicators of pending end-of-life for the unit with sufficient warning to avoid a total and sudden failure of the unit. The key indicator of health for the operation of this atomic standard is the BITE signal. If the unit BITE output is HIGH after the specified warm-up period has ended, a fault condition exists.

The LAMP V signal can also be monitored for inherent degradation of the internal pickup of the lamp light output by the photodiode (this is often called dc light voltage decay, or DCLV decay). If the LAMP V signal drops below 3 Vdc, the unit should be removed for maintenance. If the LAMP V signal exceeds 14 Vdc, the unit should be removed for service by DATUM, following the procedures described in Section 2.5.1, Repairs.

Similarly, the crystal voltage monitor (XTAL V MON) can be used to show if the crystal is drifting out of the available trim range once the warm-up period has been completed. If the XTAL V MON signal falls outside the range of 0.55 Vdc to 12.6 Vdc over the operating temperature range, the unit should be removed for service by DATUM, following the procedures described in Section 2.5.1, Repairs. This allows roughly a half volt of margin before the crystal oscillator will lose lock to the (stable) rubidium frequency. The crystal voltage will, during sweep mode, traverse through end points of  $(0.502V \pm .017V)$  on the low end and  $(13.3V \pm 0.45V)$  on the high end. These design values are used to ensure that the normal operating limits are covered by the sweep signal while minimizing the “wasted” oversweep voltage.

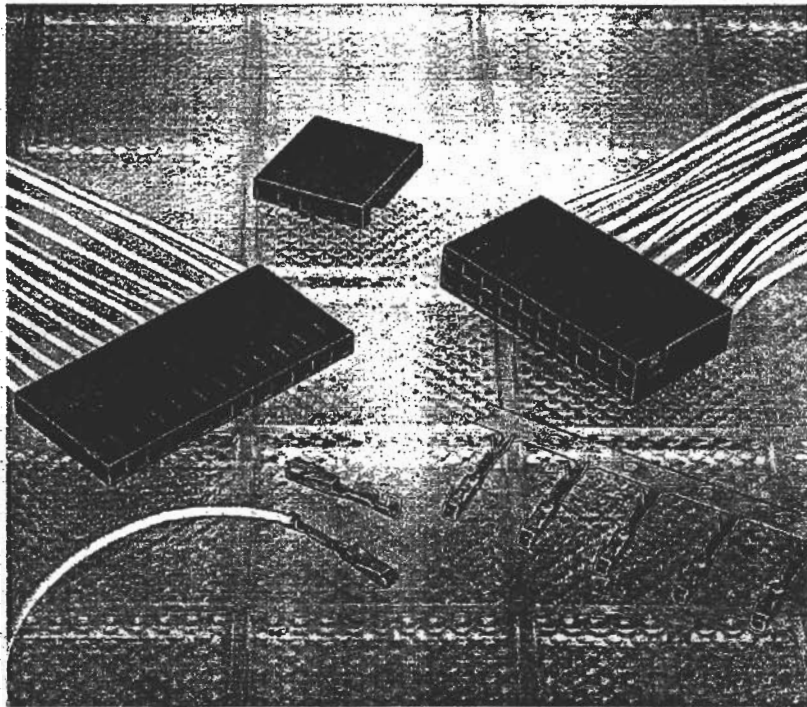
# **APPENDIX A**

## **LPRO Connector Data**

## AMP Standard Tandem Spring and Mini-Tandem Spring Receptacle Contacts

### Product Facts

- Individual contacts mate with .025 [0.64] sq. posts, .125 [3.18] long
- Crimp snap-in contacts accept 32-22 AWG [0.03-0.32 mm<sup>2</sup>] wire
- Retention latch provides for positive installation
- No insertion tool required
- High durability design provides long life
- Available with .000015 [0.00038] or .000030 [0.00076] thick gold inlay in contact areas, or bright tin plated
- Closed-entry housings
- Standard contact box size: .060 x .088 [1.52 x 1.73]
- Mini-contact box size: .060 [1.52] sq.
- Mini-Tandem Spring Housings can be stacked on .100 [2.54] centers in either direction
- Mini-Tandem Spring Housings are Recognized under the Component Program of Underwriters Laboratories Inc., File No. E28476



AMP Tandem Spring Receptacle Contacts are designed to mate with .025 [0.64] square posts. When used individually, they will mate with posts as short as .125 [3.18] and when used in a housing, they will mate with .140 [3.55] long posts. These versatile contacts may be used for interconnecting posted pc panels, I/O wiring and cross-connecting pin arrays.

The receptacle contact's box configuration provides long contact life with controlled contact mating forces which

minimize wear. An external retention spring facilitates quick assembly and assures firm seating in a contact housing.

**Standard Tandem Spring Receptacle Contacts** may be used for ganged connections in AMPMODU Mod. IV closed-entry housings having single- or double-row configurations and a centerline spacing as close as .100 [2.54]. Contacts also can be used in single-row AMPMODU MTE housings, or can be used as replacement contacts.

**Mini-Tandem Spring Receptacle Contacts** are used in single- or double-row housings with .100 [2.54] centerline spacing. Single-row housings can be converted into double-row connectors on .100 x .200 [2.54 x 5.08] centers with the use of stacking clips.

Mini-Tandem Spring Housings can be stacked side-by-side or end-to-end on .100 [2.54] centers.

Specifications subject to change.  
For latest design specifications...  
1-800-522-6752

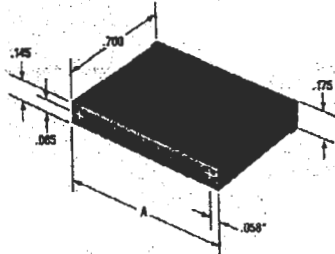
**Wire-Applied Housings for Locking  
Clip Contacts Single Row,  
.100 Centers Double Row,  
.100 x .100 Centers**

Dimensioning:  
Dimensions are in inches

**Single Row**

**Material:**  
Glass-filled nylon, 94V-0 rated

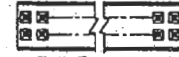
**Related Product Data:**  
Contacts - page 3175  
Matable Headers and Posts -  
Refer to the Mating Post Selection  
Guide - page 3142  
Technical Documents -  
page 3223



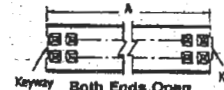
\*This dimension is .054 for the 1 position housing.



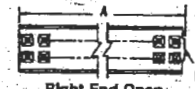
Both Ends Closed



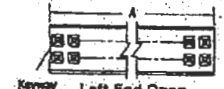
Both Ends Closed



Both Ends Open



Right End Open

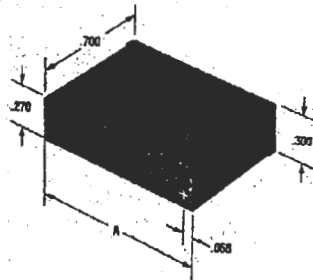


Left End Open

**Double Row**

**Material:**  
Glass-filled nylon, 94V-0 rated

**Related Product Data:**  
Contacts - page 3175  
Matable Headers and Posts -  
Refer to the Mating Post Selection  
Guide - page 3142  
Technical Documents -  
page 3223



Note: Housings illustrated above are the "Both Ends Closed" version.

**Keying Plug**

Material: Natural color nylon



Part No. 87179-1  
(Plugs directly into housings for  
.025 square-post contacts)

Housing Configuration	No. of Pos.	A Dim.	Housing Part No.	
			Stamped	Unstamped
Single Row Both Ends Closed	1	.108	—	87175-2
	2	.216	—	87175-6
	3	.316	—	87175-8
	4	.416	—	1-87175-0
	5	.516	—	1-87175-2
	6	.616	1-87175-3	1-87175-4
	7	.716	1-87175-5	1-87175-6
	8	.816	1-87175-7	1-87175-8
	9	.916	1-87175-9	2-87175-0
	10	1.016	2-87175-1	2-87175-2
	11	1.116	2-87175-3	2-87175-4
	12	1.216	2-87175-5	2-87175-6
	13	1.316	2-87175-7	2-87175-8
	15	1.516	87175-3	87175-4
	Double Row Both Ends Closed	2	.116	—
4		.216	—	87133-1
6		.316	87133-8	87133-7
8		.416	1-87133-0	87133-9
10		.516	87133-5	87133-2
12		.616	1-87133-2	1-87133-1
16		.816	1-87133-4	1-87133-3
18		.916	—	1-87133-5
20		1.016	87133-6	87133-3
Double Row Both Ends Open		4	.199	—
	10	.499	—	87125-2
	20	.999	87125-6	87125-3
Double Row Right End Open	4	.216	—	87132-1
	10	.516	—	87132-2
	20	1.016	87132-6	87132-3
Double Row Left End Open	4	.216	—	87131-1
	10	.516	—	87131-2
	20	1.016	87131-6	87131-3

Note: See AMP Instruction Sheet No. IS 7606 for proper contact orientation within the housings.

**Locking Clip Contacts**

*Specifications subject to change.*  
**For latest design specifications...**  
**1-800-522-6752**

Dimensioning:  
 Dimensions are in inches.

**Wire Crimp  
 Contacts  
 with Insulation  
 Support**

**Material:**

Contact Body—Phosphor bronze  
 Contact Spring—Stainless steel

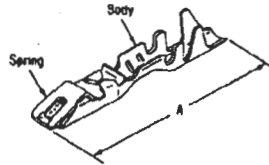
**Related Product Data:**

Housings Used With -  
 pages 3176 & 3177  
 Application Tooling - page 3221  
 Technical Documents -  
 page 3223

**Plating Specifications:**

**Sel. Gold/Nickel**—Gold flash over  
 .000050 nickel on entire contact,  
 with additional .000030 gold on  
 contact area

**Br. Tin-Lead/Nickel**—  
 .000100-.000200 bright tin-lead  
 over .000050 nickel on entire  
 contact



Wire Size Range AWG	Ins. Dia. Range	A Dim.	Plating	Part Numbers		Quick-Change Applicator for AMP-Q-ELECTRIC Machine	Hand Tool
				Strip Form	Loose Form		
30-28	.029-.039	.550	Sel. Gold/Nickel	87190-1	87191-1	687792-2	90295-1
			Br. Tin/Nickel	87190-2	87191-2		
26-22	.038-.062	.584	Sel. Gold/Nickel	87124-1	87185-1	466721-2	90289-1
			Br. Tin/Nickel	87124-2	87185-2		
20	.038-.062	.584	Sel. Gold/Nickel	867052-2	---	466721-2	---
			Br. Tin/Nickel	867052-1	---		

**Notes:** 1. These contacts must be crimped in accordance with AMP Specification No. 114-25006 in order to function properly in a connector housing.  
 2. Extraction tool No. 91084-1 is used for removing individual contacts from connector housings and for detaching contacts from mating posts.



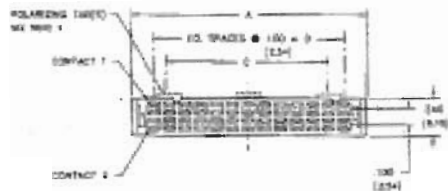
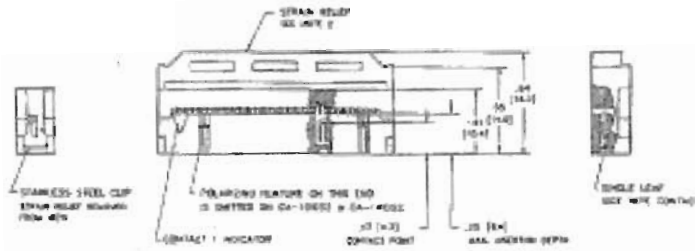
**Extraction Tool  
 Part No. 91084-1**





# INSULATION DISPLACEMENT

SOCKET - .100 X .100



**FEATURES:**

- CONFORMS TO MIL-C-83503/7C
- PIN 1 TO WIRE 1 CONSTRUCTION
- SINGLE LEAF SIDE WIRE CONTACT
- STRAIN RELIEF, PULL TABS AND CABLE ARE AVAILABLE
- SEE CABLE AND ACCESSORIES SECTION

**SPECIFICATIONS:**

**ENVIRONMENTAL:**

TEMPERATURE RANGE: +55° C TO +125° C

**MECHANICAL:**

INSULATOR MATERIAL: GLASS FILLED POLYESTER, GRAY, UL94V-0  
 CONTACT MATERIAL: BERYLLIUM COPPER  
 CONTACT INSERTION FORCE: 4 oz. (1.1 N.) TYP.  
 B oz. (2.2 N.) MAX.  
 CONTACT EXTRACTION FORCE: 2.75 oz. (0.8 N.) TYP.  
 2 oz. (0.6 N.) MIN.

\*MEASURED WITH .025 (0.64) SQ. PIN  
 RECOMMENDED WIRE SIZE: 30 AWG STRANDED, 30 AWG SOLID  
 RECOMMENDED MATING PIN SIZE: .025 (0.64) SQUARE OR ROUND

**ELECTRICAL:**

CURRENT RATING: 1 AMP  
 VOLTAGE RATING: 300 Vrms  
 DIELECTRIC WITHSTANDING VOLTAGE: 500 Vrms MIN.  
 INSULATION RESISTANCE: > 5000 Megohms  
 CONTACT RESISTANCE: < 10 Milliohms TYP.  
 25 Milliohms MAX.

MEASURED THROUGH INSULATION DISPLACEMENT PORTION AND MATING PIN

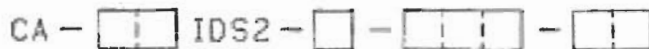
MATING CA PRODUCT: H, N3, HL AND DUAL ROW STRIP HEADERS

**TABULATION:**

NO. OF POSITIONS	A		B		C	
	IN	MM	IN	MM	IN	MM
10	.500	12.73	.400	10.16	-	-
15	.688	17.46	.500	12.70	-	-
18	.800	20.32	.700	17.78	-	-
20	1.100	27.94	.900	22.86	-	-
26	1.400	35.56	1.200	30.48	-	-
34	1.800	45.72	1.500	38.10	-	-
40	2.100	53.34	1.800	45.72	-	-
50	2.800	71.12	2.400	60.96	.300	7.62
60	3.100	78.74	2.800	71.12	1.100	27.94

**NOTES:**

1. POLARIZING TABS ARE OPTIONAL. SEE ORDERING NOMENCLATURE.
2. STRAIN RELIEF IS AVAILABLE SEPARATELY. REFER TO CABLE AND ACCESSORIES SECTION.



NUMBER OF CONTACT POSITIONS

INSULATION DISPLACEMENT SOCKET, SERIES 2

STRAIN RELIEF:

BLANK = NO STRAIN RELIEF  
 SR = WITH STRAIN RELIEF

POLARIZING TABS:

BLANK = NONE ON 10 THRU 60 POSITIONS  
 OPT = SINGLE POLARIZING TAB ON 10 THRU 60 POSITIONS  
 OPT = DUAL POLARIZING TABS ON 30 AND 60 POSITIONS ONLY

PLATING:

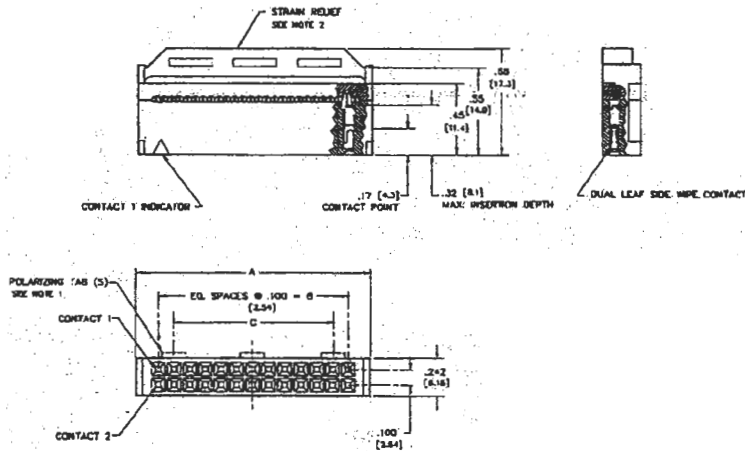
B = .00010 (.00025) GOLD OVER .000075 (.00190) NICKEL  
 F = CONTACT AREA: .000030 (.00076) GOLD  
 INSULATION DISPLACEMENT AREA: .000010 (.00254)  
 50/10 TIN/LEAD ALLOY  
 UNDERPLATE: .000075 (.00190) NICKEL  
 T = .000250 (.00508) TIN OVER .000075 (.00190) NICKEL

CIRCUIT ASSEMBLY CORP. • THOMAS ST., IRVINE CALIF. 92718-2703 PHONE: (714) 855 7807 TELEX: 8N3108 UD



# INSULATION DISPLACEMENT

SOCKET - .100 X .100



### FEATURES:

- CONFORMS TO MIL-C-83503/7C
- PIN 1 TO WIRE 1 CONSTRUCTION
- DUAL LEAF WIPE CONTACT
- STRAIN RELIEF, PULL TABS AND CABLE ARE AVAILABLE SEE CABLE AND ACCESSORIES SECTION

### SPECIFICATIONS:

#### ENVIRONMENTAL:

TEMPERATURE RANGE: -55° C TO +125° C

#### MECHANICAL:

INSULATOR MATERIAL: GLASS FILLED POLYESTER, GRAY, UL94V-0

CONTACT MATERIAL: PHOSPHOR BRONZE

CONTACT INSERTION FORCE: \* 4 oz. ( 1.1 N. ) TYP.

8 oz. ( 2.2 N. ) MAX.

CONTACT EXTRACTION FORCE: \* 3 oz. ( 0.9 N. ) TYP.

2 oz. ( 0.5 N. ) MIN.

\* MEASURED WITH .025 (0.64) SQ. PIN

RECOMMENDED WIRE SIZE: 28 AWG STRANDED, 30 AWG SOLID

RECOMMENDED MATING PIN SIZE: .025 (0.64) SQUARE OR ROUND

#### ELECTRICAL:

CURRENT RATING: 1 AMP

VOLTAGE RATING: 300 Vrms

DIELECTRIC WITHSTANDING VOLTAGE: 500 Vrms MIN.

INSULATION RESISTANCE: > 1000 Megohms

CONTACT RESISTANCE: \* 10 Milliohms TYP.

25 Milliohms MAX.

\* MEASURED THROUGH INSULATION DISPLACEMENT PORTION AND MATING PIN

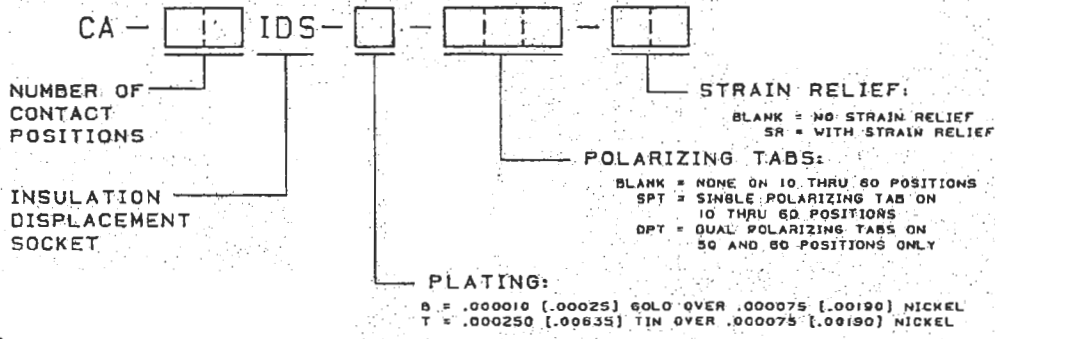
MATING CA PRODUCT: H, H3, HL AND DUAL ROW STRIP HEADERS

### TABULATION:

NO. OF POSITIONS	A		B		C	
	IN	MM	IN	MM	IN	MM
10	.680	17.27	.400	10.16	-	-
14	.880	22.35	.600	15.24	-	-
16	.980	24.89	.700	17.79	-	-
20	1.180	29.97	.900	22.86	-	-
26	1.480	37.59	1.200	30.48	-	-
34	1.880	47.75	1.600	40.64	-	-
40	2.180	55.37	1.900	48.26	-	-
50	2.580	68.07	2.400	60.96	.900	22.86
60	3.180	80.77	2.900	73.66	1.100	27.94

### NOTES:

1. POLARIZING TABS ARE OPTIONAL SEE ORDERING NOMENCLATURE
2. STRAIN RELIEF IS AVAILABLE SEPARATELY REFER TO CABLE AND ACCESSORIES SECTION.



CIRCUIT ASSEMBLY CORP. 18 THOMAS ST., IRVINE CALIF. 92718-2703 PHONE: (714) 855 7807 TELEX: 183109 UD

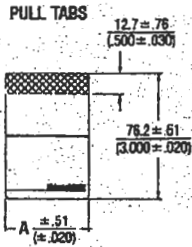
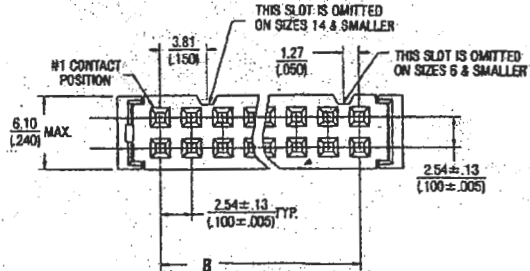
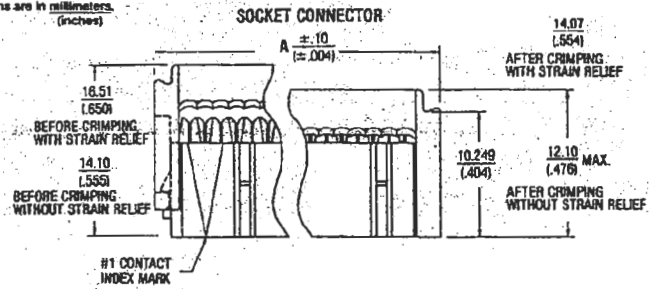
## Female Socket Transition Connector 4 to 64 Positions

**Physical Properties**  
 Insulation Material: Glass filled thermoplastic, rated 94V-0, blue.  
 Contact Material: Beryllium copper.  
 30  $\mu$  inches minimum gold over 50  $\mu$  inches nickel in contact zone; tin-lead over nickel in termination area.

**Electrical Properties**  
 Current Rating: 1 Amp  
 Insulation Resistance: > 1 x 10<sup>9</sup> Ohms @ 500 VDC  
 Dielectric Strength: > 1000 VRMS @ sea level

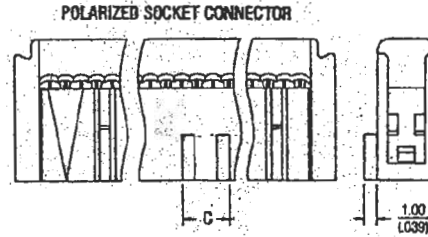
**Environmental Properties**  
 Temperature Rating: -55°C to 125°C.

Dimensions shown are for reference only.  
 Dimensions are in millimeters (inches)



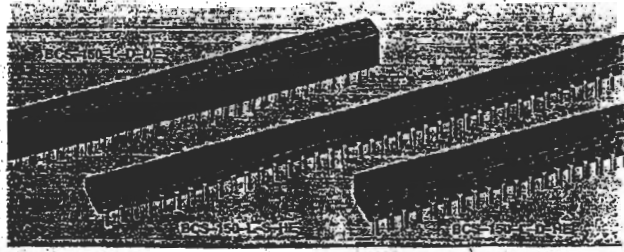
CATALOG NUMBER	A
622-3-2PT	82.6 (3.250)
622-3-1PT	78.7 (3.100)
622-2-5PT	63.5 (2.500)
622-2PT	50.8 (2.000)
622-1-5PT	38.1 (1.500)
622-1PT	25.4 (1.000)
622-5PT	12.7 (0.500)

622-0000 POLARIZING KEY FOR POLARIZING CONNECTORS BY BLOCKING CONTACT ENTRY.



### Ordering Information

SOCKET CONN.	CATALOG NUMBERS			NO. OF POS.	DIMENSIONS IN MM (INCHES)		
	SOCKET CONN. WITH STRAIN RELIEF	POLARIZED SOCKET CONN.	POLARIZED SOCKET WITH STRAIN RELIEF		A	B	C
622-0400	622-0401	622-0430	622-0441	04	9.58 (0.377)	2.54 (0.100)	1.90 (0.075)
622-0600	622-0601	622-0630	622-0641	06	12.12 (0.477)	5.08 (0.200)	1.90 (0.075)
622-1000	622-1001	622-1030	622-1041	10	17.20 (0.677)	10.16 (0.400)	3.20 (0.126)
622-1200	622-1201	622-1230	622-1241	12	19.74 (0.777)	12.70 (0.500)	3.80 (0.150)
622-1400	622-1401	622-1430	622-1441	14	22.28 (0.877)	15.24 (0.600)	3.80 (0.150)
622-1600	622-1601	622-1630	622-1641	16	24.82 (0.977)	17.78 (0.700)	3.80 (0.150)
622-2000	622-2001	622-2030	622-2041	20	29.90 (1.177)	22.86 (0.900)	3.80 (0.150)
622-2400	622-2401	622-2430	622-2441	24	34.96 (1.377)	27.94 (1.100)	3.80 (0.150)
622-2600	622-2601	622-2630	622-2641	26	37.52 (1.477)	30.48 (1.200)	3.80 (0.150)
622-3000	622-3001	622-3030	622-3041	30	42.60 (1.677)	35.56 (1.400)	3.80 (0.150)
622-3400	622-3401	622-3430	622-3441	34	47.68 (1.877)	40.64 (1.600)	3.80 (0.150)
622-3600	622-3601	622-3630	622-3641	36	50.22 (1.977)	43.18 (1.700)	3.80 (0.150)
622-4000	622-4001	622-4030	622-4041	40	55.30 (2.177)	48.26 (1.900)	3.80 (0.150)
622-4400	622-4401	622-4430	622-4441	44	60.38 (2.377)	53.34 (2.100)	3.80 (0.150)
622-5000	622-5001	622-5030	622-5041	50	68.00 (2.677)	60.95 (2.400)	3.80 (0.150)
622-6000	622-6001	622-6030	622-6041	60	80.70 (3.177)	73.66 (2.900)	3.80 (0.150)
622-6400	622-6401	622-6430	622-6441	64	85.78 (3.377)	78.74 (3.100)	3.80 (0.150)



HI-TEMP

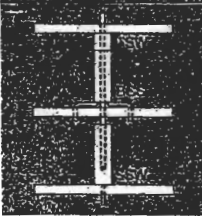
# BOX CONNECTOR STRIPS BCS SERIES

Mates with:  
TSW, MTSW, LCW, BST,  
TSS, ZSS, DW, EW, ZW,  
TLW, TSM, MTLW

**Features:**

- Low profile box connector strips
- Top entry, pass through entry, dual entry, horizontal entry
- New pass through entry for use with plated-through holes

**APPLICATION**



**Specifications:**  
**BCS**

**Insulator Material:** Black Liquid Crystal Polymer  
**Flammability Rating:** UL 94V-0  
**Insulation Resistance:** 6000 MΩ min  
**Operating Temp Range:** -65°C to +125°C  
**Max Processing Temp:** 260°C for 10 seconds and 230°C for 30 to 60 seconds  
**Withstanding Voltage:** 1000 VRMS @ 60 Hz  
**Contact Material:** Phosphor Bronze  
**Plating:** Au, PdNi or Sn over 50μ" (1.27μm) Ni  
**Current Rating:** 1A  
**Contact Resistance:** 10 mΩ max  
**Lead Size Range:** .024" (0.61mm) SQ to .028" (0.68mm) SQ  
**Insertion Depth:** .180" (4.57mm) to .290" (7.37mm) except -HE is .180" (4.57mm) to .250" (6.35mm)  
**Insertion Force:** 5 oz (1.39N) avg (.025" (0.64mm) SQ pin)  
**Withdrawal Force:** 3 oz (0.83N) avg (.025" (0.64mm) SQ pin)

**Note:** Some lengths, styles and options are non-standard, non-returnable.

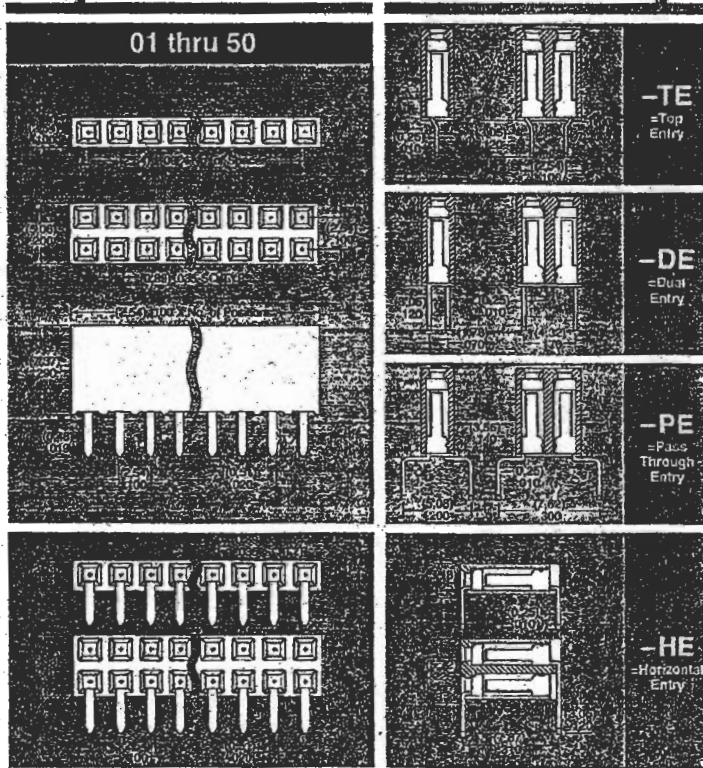
**IMPORTANT NOTE:** -DE Style connectors cannot be used with plated-through holes for bottom entry.

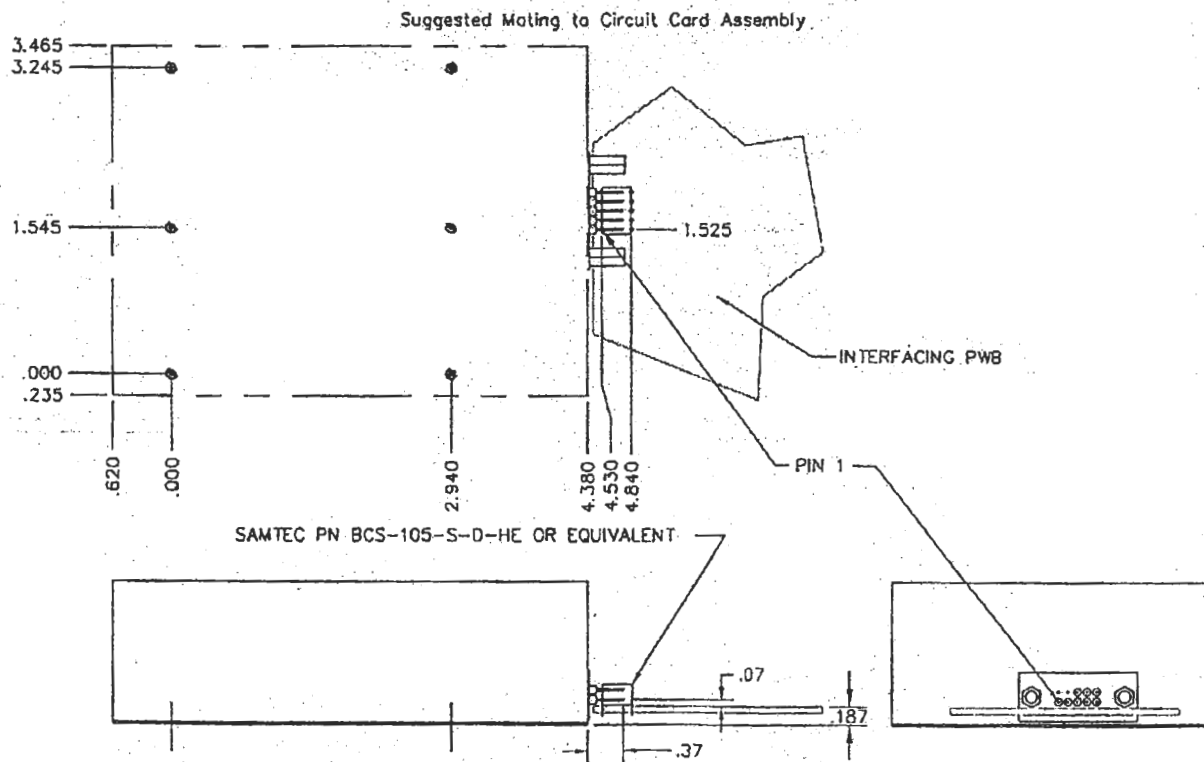
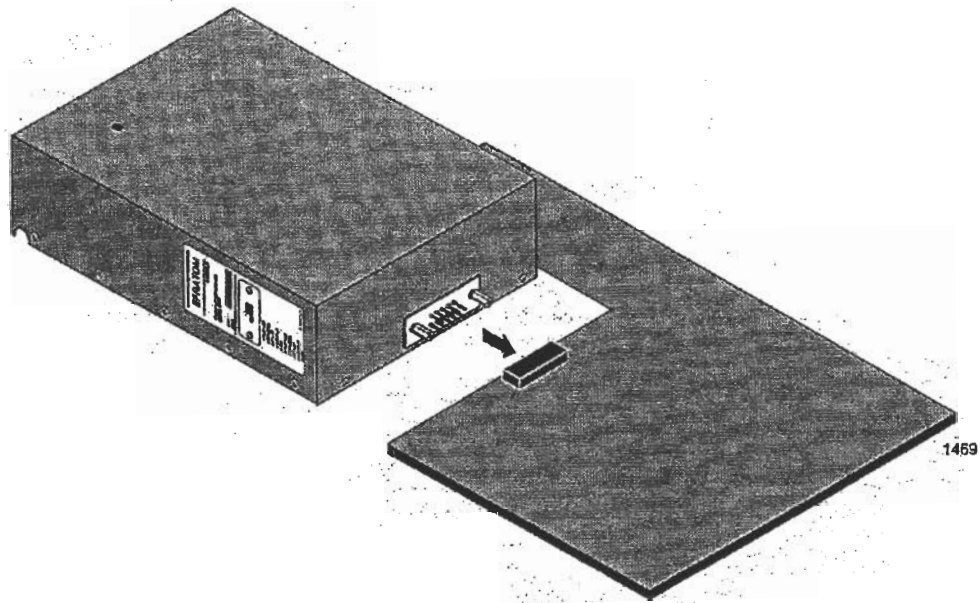


**-L =** 10μ" (0.25μm) Gold on Contact, 200μ" (5.08μm) Tin on Tail

**-S =** Single

**-D =** Double





**Figure A-1.** Suggested Mating to Circuit Card Assembly